

General Safety Information

WARNING – To avoid serious injuries:

- It is important to completely understand the operation of your bicycle's brake system. Improper use of your bicycle's brake system may result in a loss of control or an accident, which could lead to severe injury. Because each bicycle may handle differently, be sure to learn the proper braking technique (including bicycle control characteristics) and operation of your bicycle. This can be done by consulting your professional bicycle dealer and the bicycle owner's manual, and by practicing your riding and braking technique.
- When securing the brake arm to the frame, be sure to use a brake arm clip that matches the size of the chainstay, and securely tighten them with the clip screw and clip nut to the specified tightening torque. Use a lock nut with a nylon insert (self-locking nut) for the clip nut. It is recommended that standard Shimano parts be used for the clip screw, clip nut and brake arm clip. In addition, use a brake arm clip that matches the size of the chainstay. If the clip nut comes off the brake arm, or if the clip screw or brake arm clip becomes damaged, the brake arm may rotate on the chainstay and cause the handlebars to jerk suddenly, or the bicycle wheel may lock and the bicycle may fall over, causing serious injury.
- **Obtain and read the service instructions carefully prior to installing the parts.** Loose, worn, or damaged parts may cause serious injury to the rider. We strongly recommend only using genuine Shimano replacement parts.
- Check that the wheels are fastened securely before riding the bicycle. If the wheels are loose in any way, they may come off the bicycle and serious injury may result.
- Read these Technical Service Instructions carefully, and keep them in a safe place for later reference.

CAUTION – To avoid serious injuries:

- Avoid continuous application of the brakes when riding down long slopes, as this will cause the internal brake parts to become very hot, and this may weaken braking performance. It may also cause a reduction in the amount of brake grease inside the brake, and this can lead to problems such as abnormally sudden braking.
- Spin the wheel and confirm that the braking force of the coaster brake is correct.
- If the brakes are used frequently, the brake drum may become hot. Do not touch the brake drum for at least 30 minutes after you finish riding the bicycle.

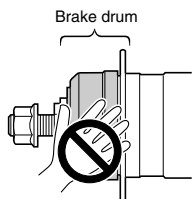

NOTE:

- Use a wheel with 3x or 4x spoke lacing. Wheels with radial lacing cannot be used because the spokes and the wheel can be damaged when applying the brakes and brake noise can be generated.
- You can shift gears while pedaling, but on rare occasions the pawls and ratchet inside the hub may produce some noise afterwards as part of normal gear shifting operation.
- If the wheel becomes stiff and difficult to turn, you should replace the brake shoes or lubricate with grease.
- Do not apply any lubricant to the inside of the hub, otherwise the grease will come out.
- You should periodically wash the sprockets in a neutral detergent and then lubricate them again. In addition, cleaning the chain with neutral detergent and lubricating it can be an effective way of extending the useful life of the sprockets and the chain.
- If the chain keeps coming off the sprockets during use, replace the sprockets and the chain.
- Parts are not guaranteed against natural wear or deterioration resulting from normal use.
- For maximum performance we highly recommend Shimano lubricants and maintenance products.
- For any questions regarding methods of handling or adjustment, please contact the place of purchase.

SI-35U0C-001

SG-3C41

Inter-3 Hub with Coaster Brake

Technical Service Instructions

Be sure to read these service instructions in conjunction with the service instructions for the Inter-3 shifting lever before use.

Installation of the hub to the frame

1. Mount the chain onto the sprocket, and then set the hub axle into the fork end.

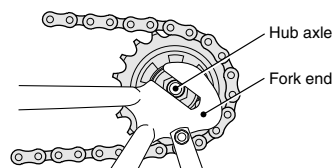

2. Place the non-turn washer onto the outside of the left side of the hub axle. At this time, turn the hub axle so that the projection of the non-turn washer fits into the groove of the fork end.

- The projecting part should be on the fork end side.
- Install the non-turn washer so that the projecting part is securely in the fork end groove on either side of the hub axle.

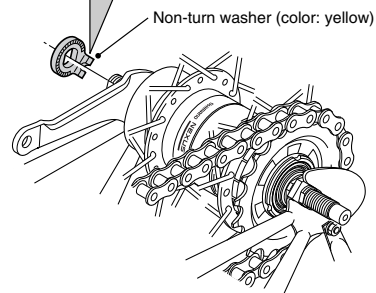

3. Screw the flange nuts onto both ends of the hub axle. After this, take up the slack in the chain and then tighten the flange nuts to secure the wheel to the frame.

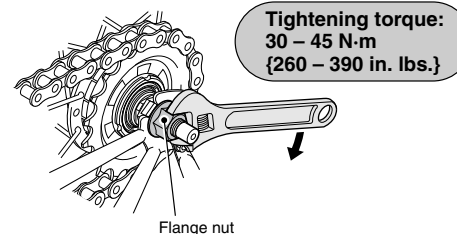

Note:

Check that the right end of the hub axle protrudes from the edge of the flange nut by about 8 - 12.5 mm.

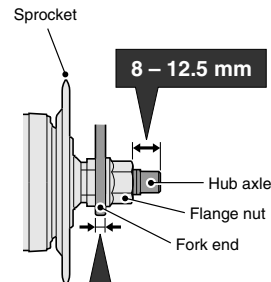

Overall dimensions of fork end, stand and mudguard stay
 4 - 7.5 mm (axle width 168 mm / 175 mm)
 9 - 12.5 mm (axle width 178 mm)

4. Fix the brake arm securely to the chainstay with the brake arm clip.

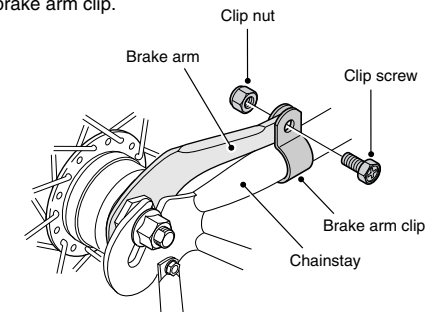

Note:

- When installing the brake arm clip, securely tighten the clip screw while holding the clip nut with a 10 mm spanner.

Tightening torque:
 2 - 3 N·m {17 - 26 in. lbs.}

- After installing the brake arm clip, check that the clip screw protrudes about 2 - 3 mm from the surface of the clip nut.

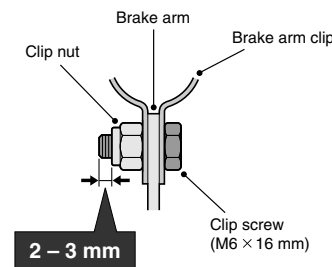

5. Before using the Coaster Brake, check that the brake works properly and that the wheel turns smoothly.

These service instructions explain how to use and maintain the Shimano bicycle parts which have been used on your new bicycle. For any questions regarding your bicycle or other matters which are not related to Shimano parts, please contact the place of purchase or the bicycle manufacturer.

Please note: Specifications are subject to change for improvement without notice. (English)

SHIMANO

SHIMANO AMERICAN CORPORATION
 One Holland, Irvine, California 92618, U.S.A. Phone: +1-949-951-5003

SHIMANO EUROPE B.V.
 Industrieweg 24, 8071 CT Nunspeet, The Netherlands Phone: +31-341-272222

SHIMANO INC.
 3-77 Oimatsu-cho, Sakai-ku, Sakai, Osaka 590-8577, Japan